

Contents

Page

Technical characteristics Han A®	01.02
Technical characteristics Han® 3 A with <i>HARAX</i> ® Termination	01.04
Han® 3 A, 3 A with <i>HARAX</i> ® Termination	01.05
Han® 4 A	01.06
Han® 10 A	01.07
Han® 16 A	01.08
Han® 32 A	01.09

Han
A

Features

- Metal and plastic version available
- Han® 3 A hoods/housings metal and plastic version available
- Han® 4 A inserts also with Han-Quick Lock® termination technology available
- Han® 10 A and 16 A inserts available in crimp and screw termination
- For currents up to 10 A (Han® 3 A / Han® 4 A) and 16 A (Han® 10 A / Han® 16 A)

Specifications

DIN EN 60 664-1
DIN EN 61 984

Approvals

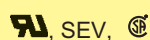

Inserts

Number of contacts 3, 4, 10, 16, 32 (2x 16) + PE

Electrical data acc. to EN 61 984

Han® 3 A / Han® 4 A **10 A 230/400 V 4 kV 3**

Rated current 10 A
 Rated voltage conductor - ground 230 V
 Rated voltage conductor - conductor 400 V
 Rated impulse voltage 4 kV
 Pollution degree 3
 or 10 A 250 V 4 kV 3

Han® 10 A / Han® 16 A **16 A 250 V 4 kV 3**

Rated current 16 A
 Rated voltage 250 V
 Rated impulse voltage 4 kV
 Pollution degree 3
 Pollution degree 2 also 16 A 230/400 V 4 kV 2

Rated voltage acc. to UL/CSA 600 V
 Insulation resistance $\geq 10^{10} \Omega$
 Material polycarbonate
 Limiting temperatures -40 °C ... +125 °C
 Flammability acc. to UL 94 V 0
 Mechanical working life - mating cycles ≥ 500

Contacts

Material	copper alloy
Surface - hard-gold plated	2 μm Au over 3 μm Ni
Surface - hard-silver plated	3 μm Ag
Contact resistance	$\leq 1 \text{ m}\Omega$
Crimp terminal - min	0.5 mm ² / AWG 20
Crimp terminal - max	4 mm ² / AWG 12
Screw terminal - min	1 mm ² / AWG 18
Screw terminal - max	2.5 mm ² / AWG 14
Tightening/test torque	0.25 Nm Han® 3 A / 4 A 0.5 Nm Han® 10 A / 16 A
Han-Quick Lock® - min	0.5 mm ² / AWG 20
Han-Quick Lock® - max	2.5 mm ² / AWG 14

Hoods/Housings, thermoplastic Han® 3 A / Han® 4 A

Material	polycarbonate RAL 7032
Locking element	polyamide RAL 7032
Flammability acc. to UL 94	V 0
Hoods/Housings sealing	NBR
Limiting temperatures	-40 °C ... +125 °C
Degree of protection acc. to DIN EN 60 529 for coupled connector	IP 65 / IP 67

Hoods/Housings, metal

Material Han® 3 A / 4 A	zinc die-cast
Material Han® 10 A / 16 A	aluminium die-cast
Locking element	
Han® 3 A / 4 A	steel, zinc-plated
Han® 10 A / 16 A	Han-Easy Lock®
Hoods/Housings sealing	NBR
Limiting temperatures	-40 °C ... +125 °C
Degree of protection acc. to DIN EN 60 529 for coupled connector	
Han® 3 A / 4 A	IP 44 IP 67 is achieved with seal screw 09 20 000 9918
Han® 10 A / 16 A	IP 65

Further selection of hoods/housings see chapter 30 / chapter 31

Accessories

Crimping tools	chapter 99
Cable clamps	chapter 40
Sealing screw	chapter 40
Coding of hoods/housings	chapter 40
Label acc. to CSA-approval	chapter 40
Assembly plates for test connector	chapter 40

Current carrying capacity

The current carrying capacity of the connectors is limited by the thermal load capability of the contact element material including the connections and the insulating parts. The derating curve is therefore valid for currents which flow constantly (non-intermittent) through each contact element of the connector evenly, without exceeding the allowed maximum temperature.

Measuring and testing techniques according to DIN EN 60 512-5

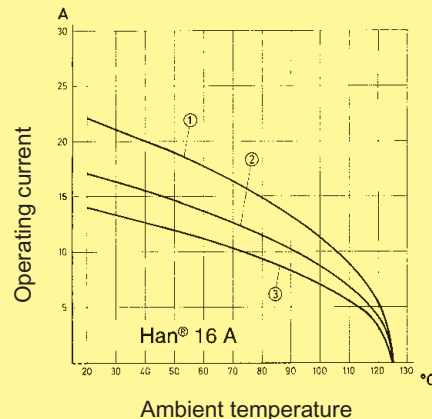
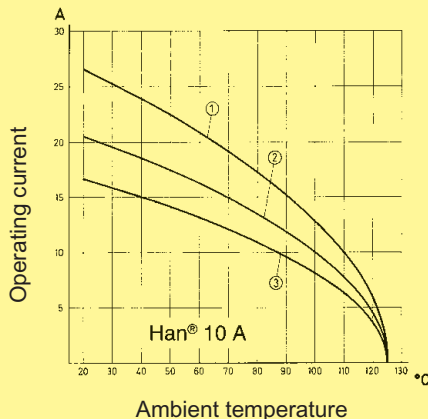
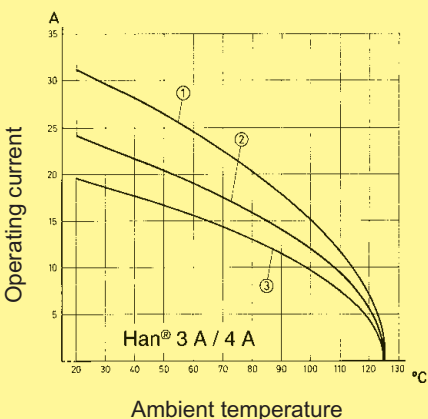

- ① Wire gauge 2.5 mm²
- ② Wire gauge 1.5 mm²
- ③ Wire gauge 1.0 mm²

Identification	Wire gauge (mm ²)	Part number		Drawing	Dimensions in mm																											
		Male contact	Female contact																													
Crimp contacts																																
silver plated																																
	0.14-0.37	09 33 000 6127	09 33 000 6227																													
	0.5	09 33 000 6121	09 33 000 6220																													
	0.75	09 33 000 6114	09 33 000 6214																													
	1	09 33 000 6105	09 33 000 6205																													
	1.5	09 33 000 6104	09 33 000 6204																													
	2.5	09 33 000 6102	09 33 000 6202																													
	3	09 33 000 6106	09 33 000 6206																													
	4	09 33 000 6107	09 33 000 6207																													
gold plated																																
	0.14-0.37	09 33 000 6117	09 33 000 6217																													
	0.5	09 33 000 6122	09 33 000 6222																													
	0.75	09 33 000 6115	09 33 000 6215																													
	1	09 33 000 6118	09 33 000 6218																													
	1.5	09 33 000 6116	09 33 000 6216																													
	2.5	09 33 000 6123	09 33 000 6223																													
	3	09 33 000 6106	09 33 000 6206																													
	4	09 33 000 6119	09 33 000 6221																													
<table border="1"> <thead> <tr> <th>Identification</th> <th>Wire gauge</th> <th>Stripping length</th> </tr> </thead> <tbody> <tr> <td>no groove</td> <td>0.14-0.37 mm²</td> <td>AWG 26-22</td> </tr> <tr> <td>no groove</td> <td>0.5 mm²</td> <td>AWG 20</td> </tr> <tr> <td>1 groove*</td> <td>0.75 mm²</td> <td>AWG 18</td> </tr> <tr> <td>1 groove</td> <td>1 mm²</td> <td>AWG 18</td> </tr> <tr> <td>2 grooves</td> <td>1.5 mm²</td> <td>AWG 16</td> </tr> <tr> <td>3 grooves</td> <td>2.5 mm²</td> <td>AWG 14</td> </tr> <tr> <td>wide groove</td> <td>3 mm²</td> <td>AWG 12</td> </tr> <tr> <td>no groove</td> <td>4 mm²</td> <td>AWG 12</td> </tr> </tbody> </table>						Identification	Wire gauge	Stripping length	no groove	0.14-0.37 mm ²	AWG 26-22	no groove	0.5 mm ²	AWG 20	1 groove*	0.75 mm ²	AWG 18	1 groove	1 mm ²	AWG 18	2 grooves	1.5 mm ²	AWG 16	3 grooves	2.5 mm ²	AWG 14	wide groove	3 mm ²	AWG 12	no groove	4 mm ²	AWG 12
Identification	Wire gauge	Stripping length																														
no groove	0.14-0.37 mm ²	AWG 26-22																														
no groove	0.5 mm ²	AWG 20																														
1 groove*	0.75 mm ²	AWG 18																														
1 groove	1 mm ²	AWG 18																														
2 grooves	1.5 mm ²	AWG 16																														
3 grooves	2.5 mm ²	AWG 14																														
wide groove	3 mm ²	AWG 12																														
no groove	4 mm ²	AWG 12																														
* on the back crimp collar																																

Han A

Features

- Time saving rapid termination technique HARAX®
- Advantages of HARAX® first in an industrial connector
- Reconnection to the same or bigger wire gauge up to 10 times
- No special tools required

Specifications

DIN EN 61 984
DIN EN 60 352-4
DIN EN 60 664-1

Approvals



Technical characteristics

Conductor cross section	0.75 - 1.5 mm ²
Cable outside diameter	6 - 9 mm
Wire diameter	≤ 2.8 mm
Wire of ind. strands	≥ 0.2 mm
Insulation material	PVC
Degree of protection	IP 65 / IP 67
Rated current	10 A
Rated voltage	230 / 400 V
Tightening torque of screw cap	8 Nm
Limiting temperatures	-40 °C ... +85 °C

Assembly instructions

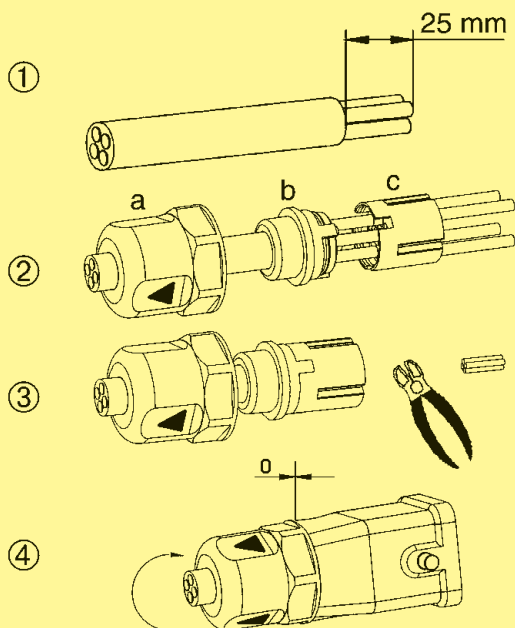

1. Strip off cable mantle
2. Assemble HARAX® elements
3. Cut off cable ends
4. The nut must be screwed completely down until the notches engage on the contact carrier nut latch

a = Screw cap

b = Sealing

c = Splice ring

Included in delivery:

Screw cap, sealing, splice ring





Number of contacts

3 +

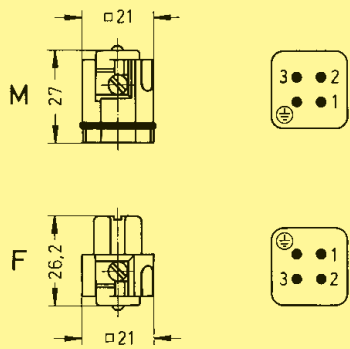

Han A

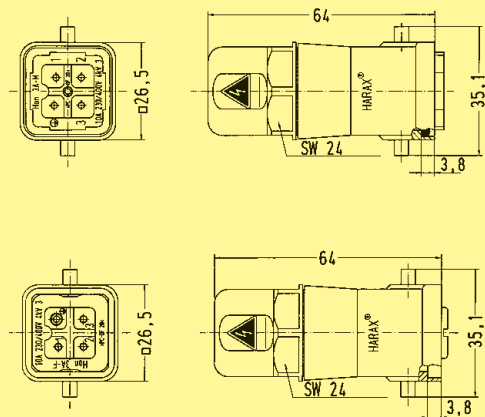
Inserts

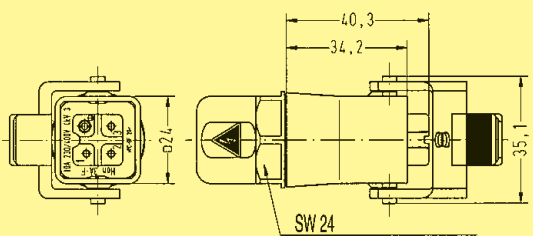
Identification	Series	Part number		Drawing	Dimensions in mm
		Male insert (M)	Female insert (F)		
<p>Screw terminal</p> 	Han A®	09 20 003 2611	09 20 003 2711	<p>Contact arrangement view from termination side</p> 	
<p>HARAX® termination</p> 	Han A®	09 20 003 0440	09 20 003 0445		
<p>Hood cable to cable with HARAX® termination</p> 	Han A®		09 20 003 0745		



Stock items in bold type

Number of contacts

4 +

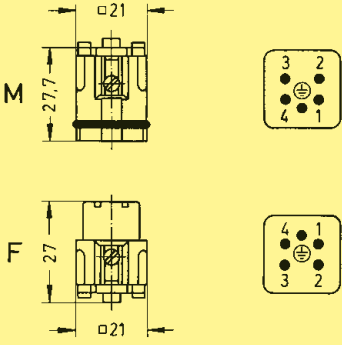

Inserts

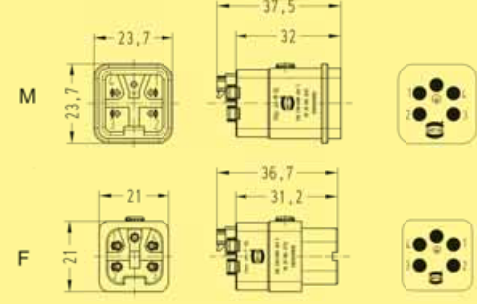
Identification	Series	Part number		Drawing	Dimensions in mm
		Male insert (M)	Female insert (F)		
<p>Screw terminal</p> 	Han A®	09 20 004 2611	09 20 004 2711	<p>Contact arrangement view from termination side</p> 	
<p>Quick Lock termination</p> 	Han A®	09 20 004 2633	09 20 004 2733	<p>Contact arrangement view from termination side</p> 	

Number of contacts

10 +

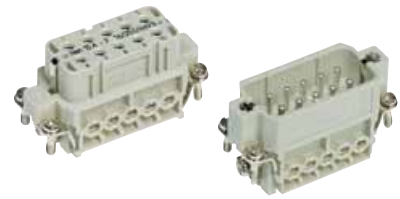

Han
A

Inserts

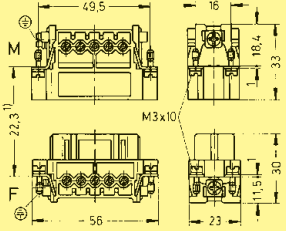
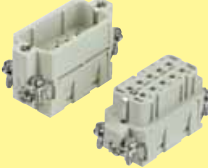
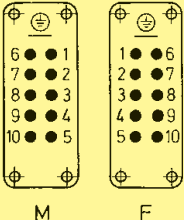
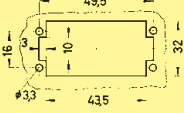
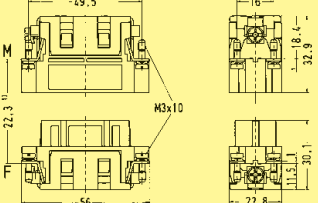
Identification	Series	Part number		Drawing	Dimensions in mm
		Male insert (M)	Female insert (F)		
<p>Screw terminal</p> 	Han A®	09 20 010 2612	09 20 010 2812	<p>Screw terminal</p>  <p>1) Distance for contact max. 24 mm</p>	
<p>Crimp terminal</p> <p>Order crimp contacts separately (see Technical characteristics on page 01.03)</p> 	Han A®	09 20 010 3001	09 20 010 3101	<p>Contact arrangement view from termination side</p>  <p>Panel cut out for inserts for use without hoods/housings</p>  <p>Crimp terminal</p>  <p>1) Distance for contact max. 24 mm</p>	



Stock items in bold type

Number of contacts

16 +

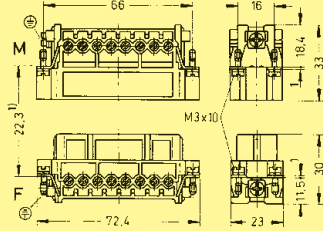

Inserts

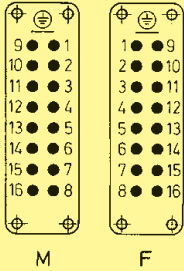
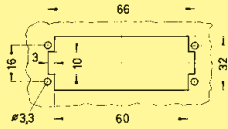
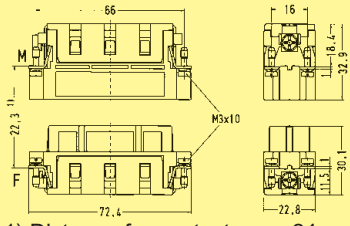
Identification	Series	Part number		Drawing	Dimensions in mm
		Male insert (M)	Female insert (F)		
<p>Screw terminal</p> 	Han A®	09 20 016 2612	09 20 016 2812	<p>Screw terminal</p>  <p>1) Distance for contact max. 24 mm</p>	
<p>Crimp terminal</p> <p>Order crimp contacts separately (see Technical characteristics on page 01.03)</p> 	Han A®	09 20 016 3001	09 20 016 3101	<p>Contact arrangement view from termination side</p>  <p>Panel cut out for inserts for use without hoods/housings</p>  <p>Crimp terminal</p>  <p>1) Distance for contact max. 24 mm</p>	

Number of contacts

32 +

Inserts

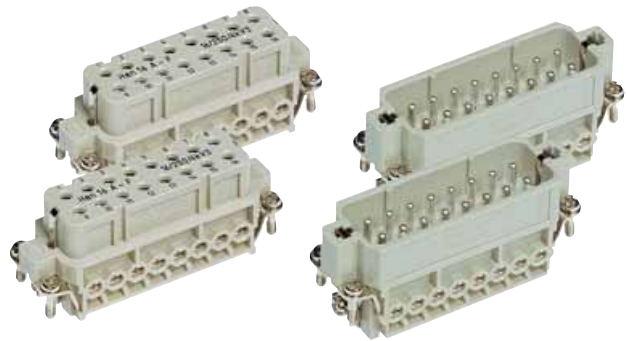

Han
A

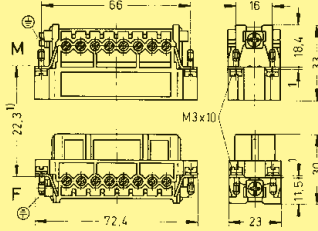
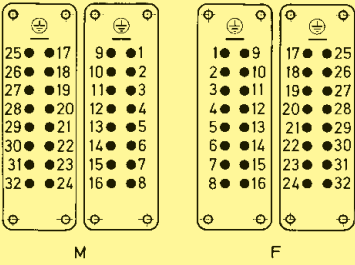
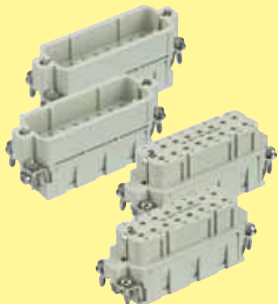
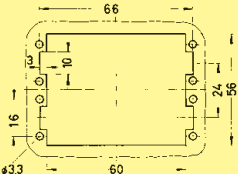
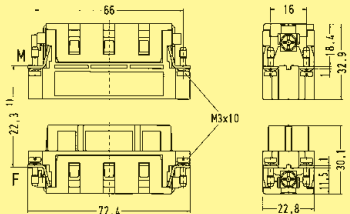
Identification	Series	Part number		Drawing	Dimensions in mm
		Male insert (M)	Female insert (F)		
<p>Screw terminal</p> 	Han A®			<p>Screw terminal</p>  <p>1) Distance for contact max. 24 mm</p> <p>Contact arrangement view from termination side</p> 	
		1 - 16 17 - 32	09 20 016 2612 09 20 016 2613		
<p>Crimp terminal</p> <p>Order crimp contacts separately (see Technical characteristics on page 01.03)</p> 	Han A®			<p>Panel cut out for inserts for use without hoods/housings</p>  <p>Crimp terminal</p>  <p>1) Distance for contact max. 24 mm</p>	
		1 - 16 17 - 32	09 20 016 3001 09 20 016 3011		